

Expressions® Sealed Gas Downdraft Cooktop Guide



600

Table of Contents

For Future Assistance 1

Safety Instructions 2-3

Ducting 3

Using Your Cooktop 4-5

Cooktop at a Glance

Setting the Controls

Heat Settings

Operating During Power Failure

Ventilation System

Care and Cleaning 6-7

Before You Call for Service 7

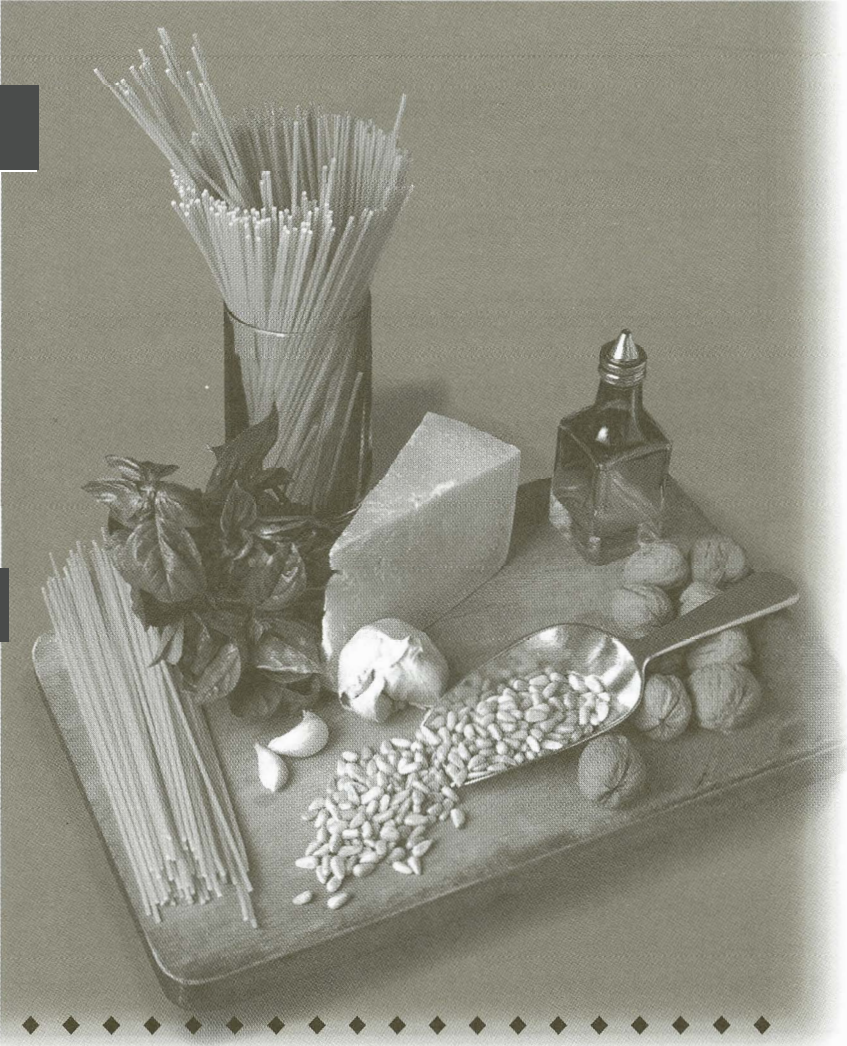

1 For Future Assistance

Congratulations on your choice of a Jenn-Air gas cooktop. Your complete satisfaction is very important to us.

Read this user's guide carefully. It is intended to help you operate and maintain your new cooktop.

In addition, you will find a booklet entitled "*Cooking Made Simple.*" It contains information on selecting cookware, pan sizes and heat setting recommendations.

Save time and money. Check the "Before You Call" section of this guide. It lists causes of minor operating problems that you can correct yourself.

However, should you need service, it is helpful to have the model and serial numbers available. This information can be found on the data plate located on the bottom of the cooktop.

These numbers are also on the Product Registration card that came with your appliance. Before sending in this card, record these numbers along with the purchase date below.

Model Number -----
Serial Number -----
Date of Purchase _____

IMPORTANT: *Keep this guide and the sales receipt in a safe place for future reference. Proof of original purchase date is needed for warranty service.*

If you have any questions, write us (include your model number and phone number) or call:

Jenn-Air Customer Assistance
1-800-688-1100
1-800-688-2080 (U.S. TTY for hearing or
speech impaired)
(Mon.-Fri., 8 am-8 pm Eastern Time)
Internet: <http://www.maytag.com>

For service information, see back page.

NOTE: In our continuing effort to improve the quality and performance of our cooking products, it may be necessary to make changes to the appliance without revising this manual.

! WARNING: *If the information in this manual is not followed exactly, a fire or explosion may result causing property damage, personal injury or death.*

Do not store or use gasoline or other flammable vapors and liquids in the vicinity of this or any other appliance.

WHAT TO DO IF YOU SMELL GAS

- ◆ **Do not try to light any appliance.**
- ◆ **Do not touch any electrical switch.**
- ◆ **Do not use any phone in your building.**
- ◆ **Immediately call your gas supplier from a neighbor's phone. Follow the gas supplier's instructions.**
- ◆ **If you cannot reach your gas supplier, call the fire department.**
- ◆ **Extinguish any open flame.**

Installation and service must be performed by a qualified installer, service agency or the gas supplier.

**SAVE THESE INSTRUCTIONS
FOR FUTURE REFERENCE**

Important Safety Instructions 2

Read before operating your cooktop

All appliances - regardless of the manufacturer - have the potential through improper or careless use to create safety problems. Therefore the following safety precautions should be observed. Please retain this guide for future reference.

1. Be sure your appliance is properly installed and grounded by a qualified technician. Installer - please leave this guide with the appliance.
2. Never use your appliance for warming or heating the room. This warning is based on safety considerations.
3. Children should not be left alone or unattended in area where appliance is in use. They should never be allowed to sit or stand on any part of the appliance.
4. Wear proper apparel. **Loose-fitting or hanging garments** should never be worn while using the appliance.
5. Do not repair or replace any part of the appliance unless specifically recommended in this manual. All other servicing should be referred to an authorized Jenn-Air Service Contractor.
6. Do not store combustible materials, gasoline or other flammable vapors and liquid near cooktop.
7. Do not use water on grease fires. Smother fire or flame or use dry chemical or foam-type extinguisher.
8. Use only dry potholders. Moist or damp potholders on hot surfaces may result in burns from steam. Do not use a towel or other bulky cloth.
9. Select cookware large enough to properly contain food and avoid boilovers or spillovers. This will save on cleaning and prevent hazardous accumulations of food, since heavy splattering or spillovers left on a cooktop **can** ignite. Pan size is especially important in deep fat frying.
10. Do not allow large pans to extend beyond the edge of the surface burner grates. Refer to page 4, "Using Your Cooktop" for large pan usage guidelines.
11. Never leave cooktop unattended at **Hi** heat settings. Boilover causes smoking and greasy spillovers that may ignite.
12. **TYPE OF COOKWARE** - Avoid pans that are unstable and easily tipped. Pans that are too heavy when filled with food can also be a hazard. If pan handles twist and cannot be tightened, discard the pan.
13. **HANDLES** - Always turn pan handles to the side or back of the cooktop - not out into the room where they are easily hit. **COOKWARE HANDLES SHOULD BE TURNED INWARD AND NOT EXTEND OVER ADJACENT SURFACE BURNERS** to minimize burns, ignition of flammable materials, and spillage due to unintentional contact with the cookware.
14. **CAUTION** - Do not store items of interest to children in cabinets above cooktop-children climbing on the cooktop to reach items could be seriously injured.
15. Do not touch surface burner areas or any areas near burners. During and after use, these areas may be hot enough to cause burns. Avoid contact with these areas by clothing or other flammable materials until they have had sufficient time to cool.
16. Do not heat unopened food containers. Build-up of pressure may cause container to burst and result in injury.
17. Keep all controls "**Off**" when unit is not in use.
18. **GREASE** - Grease is flammable and should be handled carefully. Never leave any cooking operation unattended. Let fat cool before attempting to handle it. Do not allow grease to collect around the cooktop. Wipe up spillovers immediately.
19. If the cooktop is installed near a window, proper precautions should be taken to prevent curtains from blowing over burners creating a **FIRE HAZARD**.
20. Do not use aluminum foil to line burner spillover bowl. Restriction of normal air flow may result in unsafe operation.
21. Clean only parts listed in this manual and use procedures recommended.
22. Always allow hot pans to cool in a safe place out of the reach of small children.
23. A faint gas odor may indicate a gas leak. If a gas odor is detected, shut off the gas supply to the cooktop. Call your installer or local gas company to have the possible leak checked. **Never use a match or other flame to locate a gas leak.**

. . . more

3 Important Safety Instructions

- 24. Flame size should be adjusted so it does not extend beyond the edge of the cookware. This instruction is based on safety consideration.
- 25. This appliance has been tested for safe performance using conventional cookware. Do not use any devices or accessories that are not specifically recommended in this manual. Do not use eyelid covers for the surface burners or stovetop grills. The use of devices or accessories that are not expressly recommended in this manual can create serious safety hazards, result in performance problems and reduce the life of the components of the appliance.
- 26. Before servicing shut off electrical power supply to appliance.
- 27. Keep vent area unobstructed when in use.

WARNING

Electrical Grounding Instructions

The appliance is equipped with a three-prong grounding plug for your protection against shock hazard and should be plugged directly into a properly grounded three-prong receptacle. Do not cut or remove the grounding prong from this plug.

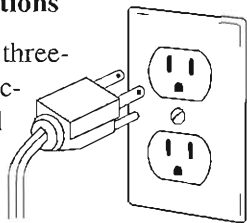

IMPORTANT SAFETY NOTICE AND WARNING

The California Safe Drinking Water and Toxic Enforcement Act of 1986 (Proposition 65) requires the Governor of California to publish a list of substances known to the State of California to cause cancer or reproductive harm, and requires businesses to warn customers of potential exposures to such substances.

Users of this appliance are hereby warned that the burning of gas can result in low-level exposure to some of the listed substances, including benzene, formaldehyde and soot, due primarily to the incomplete combustion of natural gas or liquid petroleum (LP) fuels. Properly adjusted burners will minimize incomplete combustion. Exposure to these substances can be minimized by properly venting the cooktop to the outdoors.

IMPORTANT NOTICE REGARDING PET BIRDS:

Never keep pet birds in the kitchen or in rooms where the fumes from the kitchen could reach. Birds have a very sensitive respiratory system. Fumes released during an oven self-cleaning cycle may be harmful or fatal to birds. Fumes released due to overheated cooking oil, fat, margarine and overheated non-stick cookware may be equally harmful.

SAVE THESE INSTRUCTIONS

Ducting

Ducting Considerations

Jenn-Air's ventilation system is designed to capture both cooking fumes and smoke from the cooktop surface. If the system does not, these are some ducting installation situations to check:

- ◆ 6" diameter round or 3 1/4" x 10" rectangular ducting should be used for duct lengths 10'-60'. **Note: 5" diameter round ducting must be used for venting straight out the back of the cooktop and directly through the wall for 10' or less.**
- ◆ No more than three 90° elbows should be used. Distance between elbows should be at least 18".

- ◆ Recommended Jenn-Air wall cap **MUST** be used. Make sure damper moves freely when ventilation system is operating.
- ◆ There should be a minimum clearance of 6" for cooktop installed near a side wall.

If there is not an obvious improper installation, there may be a concealed problem such as a pinched joint, obstruction in the pipe, etc. Installation is the responsibility of the installer and questions should be addressed first by the installer. The installer should very carefully check the ducting installation instructions.

Cooktop at a Glance

Your cooktop is equipped with two small and two large burners.

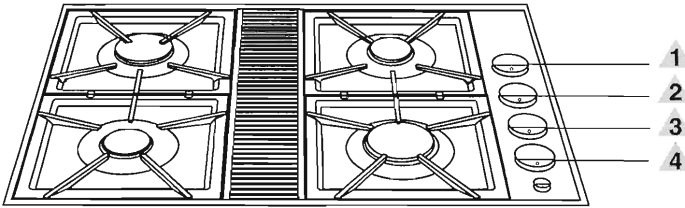

1. Left rear surface burner (10,500 BTUs).
2. Left front surface burner (6,500 BTUs).
3. Right rear surface burner (6,500 BTUs).
4. Right front surface burner (12,000 BTUs).

Setting the Controls

Your cooktop has sealed gas burners with automatic re-ignition. If the burner flame should go out, the system will automatically spark to reignite the burner.

1. Place a pan on the burner grate. (To preserve the grate finish, do not operate the burner without a pan on the grate to absorb the heat from the burner flame.)
2. Push down the control knob and turn immediately counterclockwise to the desired setting. (Ignitor will spark and click, at any position, until there is a flame.)

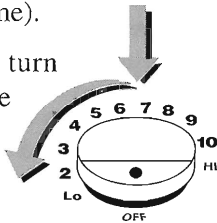

Burner Heat Settings

The size and type of cookware will affect the heat setting. For information on cookware, refer to *"Cooking Made Simple"* booklet.

The controls offer flexibility in heat setting selection. An infinite number of settings exist between **Hi** and **Lo**. At the **Hi** setting, a detent can be felt. For all settings other than **Hi**, simply adjust your flame for best results.

The following suggested settings are provided as guidelines.

Hi: To start foods cooking quickly, to bring liquids to a boil.

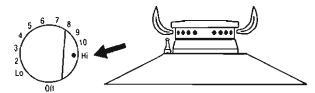

6-10: For browning of foods and (Med. rapid boil of large amounts of food.

4-5: For most frying, and slow (Med.) boil of large amounts of food.

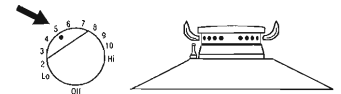

2-3: To continue cooking foods (Med. started on higher settings. Lo)

Lo: To keep foods warm and to melt butter or chocolate.

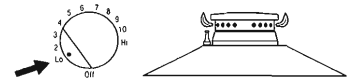

Notes . . .

- ◆ All ignitors will spark and click when any surface burner knob is turned on. However, only the selected burner will light.
- ◆ A properly adjusted burner with clean ports will light within a few seconds. The cone-shaped flame will be clear blue in color with a deeper blue inner core; there should be no trace of yellow in the flame. (With LP gas, some yellow in the flame is acceptable.)

If the burner flame is yellow, lifts off the ports or is noisy, the air/gas mixture may be incorrect. Contact a service technician to adjust.

- ◆ Match the pan size to the surface burner. The use of undersized pans will expose the flame.
- ◆ Do not allow large pans to extend over the control knobs. Heat trapped between large pans and the knobs could cause the knobs to become hot.



- ◆ Do not let the burner flame extend beyond the edge of the pan.
- ◆ Do not allow large pans to extend beyond the edge of the surface burner grates. Heat trapped between large pans and other surfaces could possibly cause surfaces to become hot to the touch or damage these areas.

To prevent damage to other surfaces when using a large pan, you may purchase a "Big Pot" Canning Grate (Model AG146) accessory. Contact your dealer or call 1-800-JENN-AIR.

- ◆ Leave a minimum of 1 1/2" between the side of a pan and surrounding side surfaces, such as a countertop backsplash or side walls. This will allow heat to escape and prevent damage to the side surfaces.

5 Using Your Cooktop

Operating During Power Failure

To light, hold a lighted match to the desired surface burner near the burner ports. Push down and slowly turn the control knob counterclockwise to the **Hi** setting.

Notes . . .

- ◆ Do not leave the cooktop unattended when cooking during a power failure. The automatic re-ignition feature will not operate during a power failure.
- ◆ During a power failure, the fan will not operate so smoke and condensation may gather.

Ventilation System

The built-in ventilation system removes cooking vapors, odors and smoke from foods prepared on your cooktop.

- ◆ The fan control is located at the front of the control panel. To operate turn the fan control knob clockwise. The variable speed fan can be operated in an infinite number of settings.
- ◆ Besides using the ventilation system to remove cooking vapors and fumes, it can be used to cool baked pies, cakes or hot pans. To cool an item, set it on the air grille and turn on the fan. The air being pulled over the item will quickly cool it. Be careful not to cover the entire air grille.
- ◆ The fan can be used to remove strong odors from the kitchen as when chopping onions near the fan.

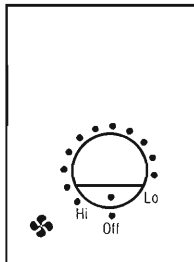

Care and Cleaning of the Ventilation System

- ◆ **Air Grille:** The air grille lifts off easily. Wipe clean or wash in dishwasher or sink with mild household detergents. To prevent scratching the surface, do not use abrasive cleaners or scrubbing pads.
- ◆ **Filter:** Turn off ventilation system before removing. The filter is a permanent type and should be cleaned when soiled. Clean in sink with warm water and detergent or in dishwasher.

IMPORTANT: DO NOT OPERATE SYSTEM WITHOUT FILTER.

Filter should always be placed at an angle. As you face the front of the cooktop, the bottom of the filter should rest on the ledge on the left side. The top of the filter should rest against the right side. There are also ledges on the front and rear

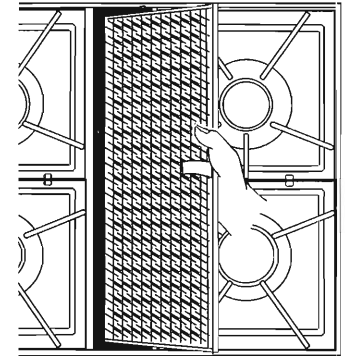

sides for the filter to rest. (*Note: If filter is flat against the fan wall, ventilation effectiveness is reduced.*)

- ◆ **Ventilation Chamber:** This area, which houses the filter, should be cleaned in the event of spills or whenever it becomes coated with a film of grease. It can be cleaned with paper towel, damp cloth, or sponge and mild household detergent or cleanser.

Be sure all controls are OFF and all cooktop parts are cool before cleaning.

Cleaning Chart	
Parts	Cleaning Procedure
Control Knobs	<ul style="list-style-type: none"> ◆ Remove knobs in the OFF position by pulling each knob straight up. Never pry off with a metal blade. ◆ Wash in dishwasher or in warm, soapy water. <i>Do not soak or use abrasive cleaners such as steel wool pads.</i> Rinse and dry. ◆ Replace knobs, matching the flat part of the knob opening with the flat part of the shaft. Make sure knobs are in the OFF position. Never hit the knob on the shaft with your hand or any other object when replacing. <p><i>NOTE: When knobs are removed for cleaning, be careful not to spill liquids through the holes in the control area.</i></p>
Glass Control Panel	<ul style="list-style-type: none"> ◆ Wipe with a clean, damp sponge or cloth. Rinse and dry thoroughly to prevent a filmy residue. A glass cleaner or mild liquid spray may be used to remove smudge marks and stains. Do not use abrasive cleansers or S.O.S.* pads.
Stainless Steel Trim	<ul style="list-style-type: none"> ◆ Use mild liquid sprays, wipe with damp cloth or sponge. Rinse and dry. Polish with glass cleaner if necessary.
Ignitors	<ul style="list-style-type: none"> ◆ Clean with a toothbrush and warm soapy water. Rinse and dry thoroughly. DO NOT STRIKE or PRY the ignitor. (Refer to illustration of surface burner head on the following page for location of ignitors.)
Porcelain Burner Pan	<ul style="list-style-type: none"> ◆ Never wipe a warm or hot porcelain enamel surface with a damp cloth. For general cleaning, wipe with soapy cloth, rinse and dry. To remove grease, spray with cleaners such as Fantastik or 409*. DO NOT use abrasive cleaning agents. They may damage the surface. For stubborn soils clean with Cooktop Cleaning Creme (Part #20000001)**. <p><i>NOTE: The porcelain enamel used on your cooktop is acid resistant, not acid proof. Therefore, acid foods (such as vinegar, tomato, milk, etc.) spilled on the cooktop should be wiped up immediately with a dry cloth.</i></p>
Surface Burner Grates	<ul style="list-style-type: none"> ◆ Wash grates with warm, soapy water and a nonabrasive, plastic, scrubbing pad or in the dishwasher. For stubborn soils, clean with a soap-filled, nonabrasive, plastic pad or Cooktop Cleaning Creme (Part # 20000001)** and a sponge. ◆ The grates are made of porcelain on cast iron and are very durable, however, they will gradually lose their shine and/or discolor. This is due to exposure to high temperatures from the gas flame. ◆ When replacing the grates, place the rear grate on the cooktop with the grate guide toward the front. Then, add the front grate by positioning the grate guide under the rear grate and lowering onto the cooktop.

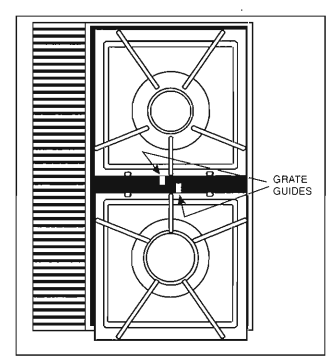

* Brand names are trademarks of the respective manufacturers.

** To order call 1-800-688-8408.

... more

7 Care and Cleaning

Surface Burner Heads and Burner Bases

- ◆ The surface burner heads are removable. The cap portion of the head is porcelain and the port area is aluminum. Wash the burner heads in the sink with mild detergent and a plastic scrubber. For stubborn stains, clean with Cooktop Cleaning Creme (Part #20000001)**.
- ◆ Check to be sure all ports are open. To open clogged ports, insert a straight pin directly into each port. Do not enlarge or distort the port.
- ◆ The aluminum burner base is not removeable. To clean, wipe with a damp cloth.
- ◆ When replacing the burner heads, carefully align the tab on the burner base with the indentation in the head. The two pins will fit in the slots when the tab is aligned with the indentation.

NOTE: When burner heads are removed for cleaning, do not spill liquids through the holes in the burner base.

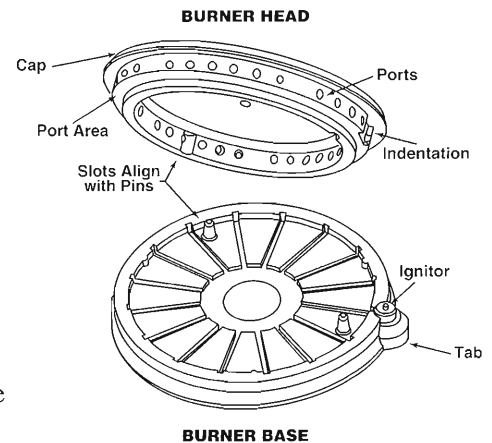

* Brand names are trademarks of the respective manufacturers.

** To order call 1-800-688-8408.

Before You Call For Service

Check the following list to be sure a service call is really necessary.

If surface burner fails to light:

- ◆ check to be sure unit is properly connected to power supply.
- ◆ check for a blown fuse or a tripped main circuit breaker.
- ◆ check to be sure burner is correctly rated for your type of gas.
- ◆ check to be sure burner ports or ignition ports are not clogged.
- ◆ check to be sure ignitor is dry and clicking. Burner will not light if ignitor is damaged, soiled or wet. If ignitor doesn't click, turn control knob OFF.
- ◆ check to be sure the burner head is correctly seated on the burner base.

If the flame is uneven:

- ◆ burner ports may be clogged.
- ◆ make sure the burner head is correctly seated on the burner base.

If surface burner flame lifts off the ports:

- ◆ contact an authorized Jenn-Air Servicer.

If surface burner flame is yellow in color:

- ◆ contact an authorized Jenn-Air Servicer.
- ◆ some yellow tips on the flames are acceptable when using LP gas.

If ventilation system is not capturing smoke efficiently:

- ◆ check on cross ventilation in room or make up air.
- ◆ outside wallcap may be trapped shut.
- ◆ cooktop may be improperly installed (see p. 3); check installation instructions.
- ◆ check filter installation (see p. 5).

If You Need Service

- ◆ Call the dealer from whom your appliance was purchased or call Maytag Appliances Sales Company, Jenn-Air Customer Assistance at 1-800-688-1100 to locate an authorized servicer.
 - ◆ Be sure to retain proof of purchase to verify warranty status. Refer to WARRANTY for further information on owner's responsibilities for warranty service.
 - ◆ If the dealer or service company cannot resolve the problem, write to Maytag Appliances Sales Company, Attn: CAIR® Center, P.O. Box 2370, Cleveland, TN 37320-2370, or call **1-800-688-1100**. U.S. customers using TTY for deaf, hearing impaired or speech impaired, call 1-800-688-2080.
- NOTE:** When writing or calling about a service problem, please include the following information:
- a. Your name, address and telephone number;
 - b. Model number and serial number;
 - c. Name and address of your dealer or servicer;
 - d. A clear description of the problem you are having;
 - e. Proof of purchase (sales receipt).
- ◆ User's guides, service manuals and parts information are available from Maytag Appliances Sales Company, Jenn-Air Customer Assistance.

JENN-AIR

403 WEST FOURTH STREET NORTH • NEWTON, IA 50208